

lamaPLC Communication: WS2812

WS2812 is a intelligent control LED light source that the control circuit and **RGB chip** are integrated in a package of **4020, 2020, 3535, 5050** components. It internal include intelligent digital port data latch and signal reshaping amplification drive circuit. Also include a precision internal oscillator and a 12V voltage programmable constant current control part, effectively ensuring the pixel point light color height consistent.



The data transfer protocol use single **NZR** communication mode. After the pixel power-on reset, the DIN port receive data from controller, the first pixel collect initial 24bit data then sent to the internal data latch, the other data which reshaping by the internal signal reshaping amplification circuit sent to the next cascade pixel through the DO port. After transmission for each pixel the signal to reduce 24bit.

Pixel adopt auto reshaping transmit technology, making the pixel cascade number is not limited the signal transmission, only depend on the speed of signal transmission. LED with low driving voltage, environmental protection and energy saving, high brightness, scattering angle is large, good consistency, low power, long life and other advantages. The control chip integrated in LED above becoming more simple circuit, small volume, convenient installation.

WS2812B

WS2812B is the development and new generation of product based on WS2812. It not only inherited all the good qualities of WS2812 but also improved the IC from mechanical arrangement outside to the structure inside, further enhance the stability and efficiency. An extrude advantage of is that the RGB chip on WS2812B has a higher brightness and color uniformity than WS2812. Despite its similar size, the WS2812B strip contains four pins as opposed to six pins on the WS2812.

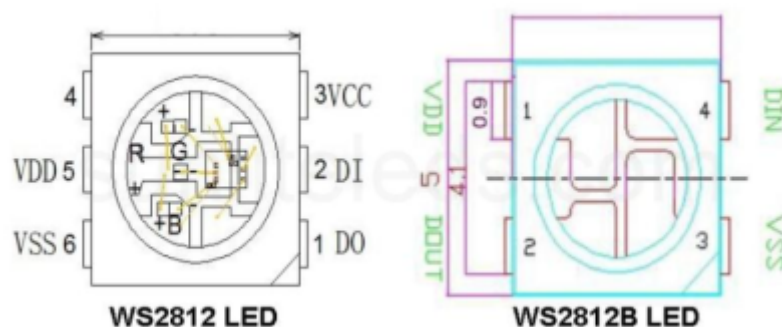

WS2812B Hardware Overview

At first glance, the WS2812B LED may appear to be a standard 5050-sized (5x5mm) SMD RGB LED, but it is much more than that. It actually contains an integrated circuit inside. Below is a zoomed-in image of the WS2812B.

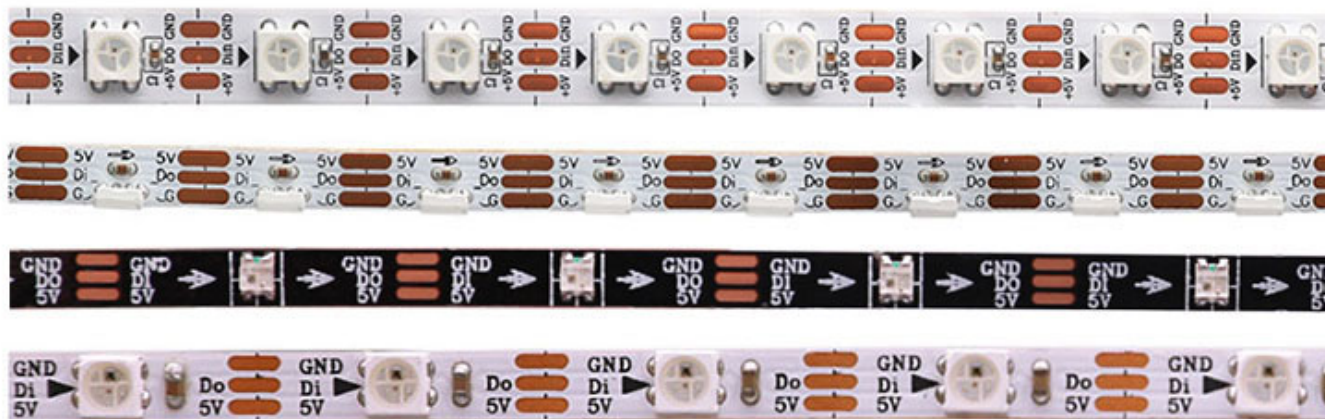

PIN configuration

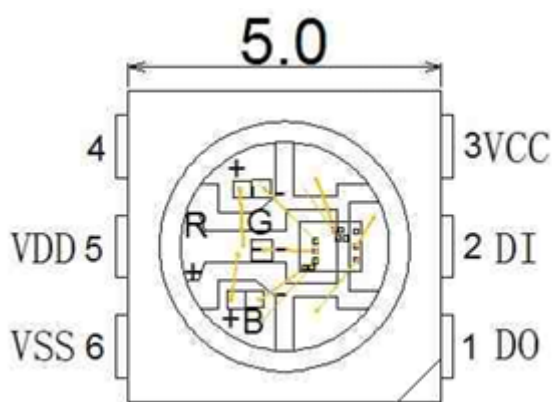

PIN	Symbol	Function description
1	DOUT	control data signal output
2	DIN	control data signal input
3	Vcc	power supply control unit
4	NC	-
5	Vdd	power supply LED
6	Vss	Ground

Technical description

Parameter	Symbol	Rated	Unit
Power supply voltage	VCC	+6.0 .. +7.0	V
Power supply voltage	VDD	+6.0 .. +7.0	V
Input voltage	VI	-0.5 .. VDD+0.5	V
Operation junction temperature	Topt	-25 .. +80	°C
Storage temperature range	Tstg	-55 .. +150	°C

LED characteristic parameter

Emitting color	Wavelength (nm)	Luminous intensity (mcd)	Current (mA)	Voltage (V)
Red	620-630	550-700	20	1.8-2.2
Green	515-530	1100-1400	20	3.0-3.2

Emitting color	Wavelength (nm)	Luminous intensity (mcd)	Current (mA)	Voltage (V)
Blue	465-475	200-400	20	3.2-3.4

Data transfer time

$$T_H + T_L = 1.25 \mu s \pm 600 \text{ ns}$$

T0H	0 code, high voltage time	0.35us	±150ns
T1H	1 code, high voltage time	0.7us	±150ns
T0L	0 code, low voltage time	0.8us	±150ns
T1L	1 code, low voltage time	0.6us	±150ns
RES	low voltage time	Above 50μs	

Sequence chart:

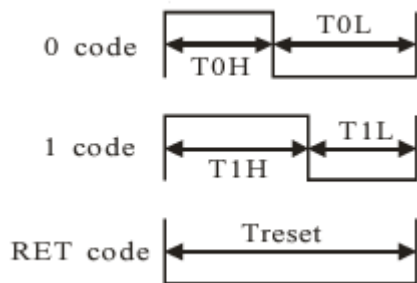

Cascade method:

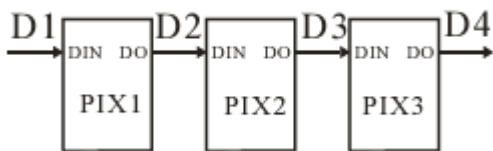

Data transmission method:

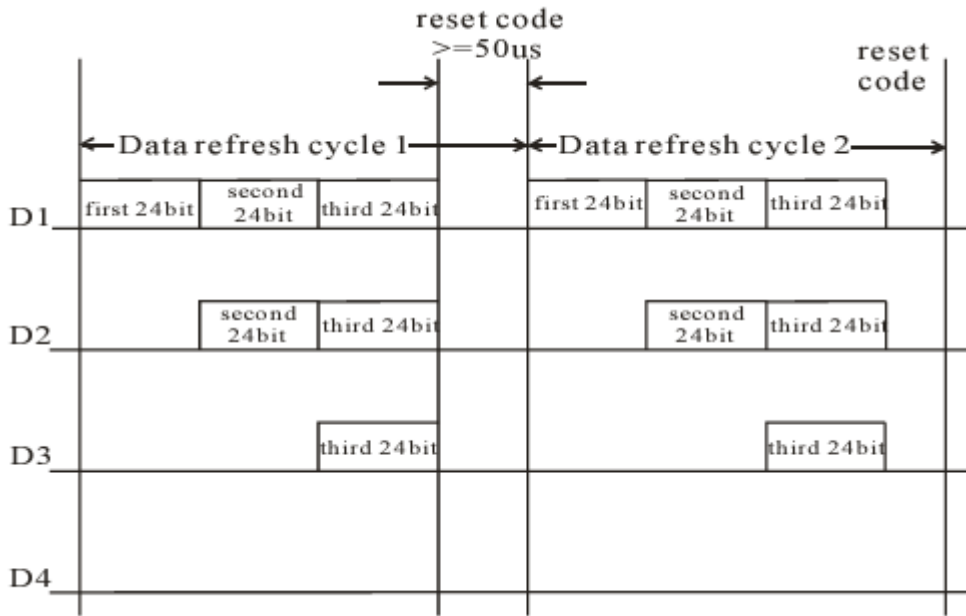

Note: The data of D1 is sent by MCU, and D2, D3, D4 through pixel internal reshaping amplification to transmit.

Composition of 24 bit data:

G7	G6	G5	G4	G3	G2	G1	G0	R7	R6	R5	R4	R3	R2	R1	R0	B7	B6	B5	B4	B3	B2	B1	B0
----	----	----	----	----	----	----	----	----	----	----	----	----	----	----	----	----	----	----	----	----	----	----	----

Note: Follow the order of GRB to send data and the high bit sent at first.

Typical application circuit:

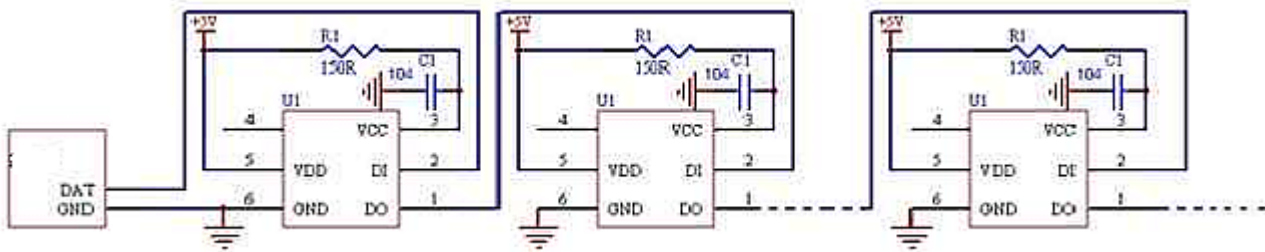

WS2812 / WS2812B with Arduino

[WS2812 FX Library for Arduino](#) and ESP microprocessors.

This library features a variety of blinken effects for WS2811/WS2812/NeoPixel LEDs.

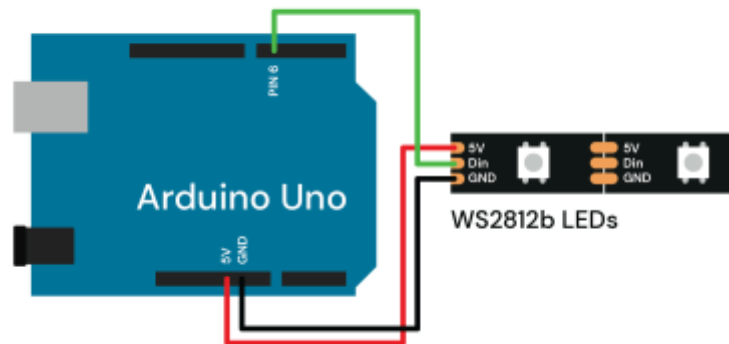

Sources

Wikipedia ([Adafruit WS2813 pdf](#))

WS2812 topics on lamaPLC

Page	Date	Tags
<ul style="list-style-type: none"> • lamaPLC Communication: WS2812 	2024/11/16 00:36	bus , communication , ws2812 , ws2812b , ws 2812 , ws 2812 b , 5050smd , 4020 , 2020 , 3535 , 5050 , nzs , rgb chip , led , arduino , rgb

[bus](#), [communication](#), [WS2812](#), [WS2812B](#), [WS 2812](#), [WS 2812 B](#), [5050SMD](#), [4020](#), [2020](#), [3535](#), [5050](#), [NZR](#), [RGB chip](#), [LED](#), [Arduino](#), [RGB](#)

This page has been accessed for: Today: 4, Until now: 5

From: <https://www.lamaplc.de/> - lamaPLC

Permanent link: https://www.lamaplc.de/doku.php?id=com:basic_ws2812

Last update: **2026/04/21 20:47**

